

Part number

# CSHM 06



## Brief description:

male insert, 6 poles + PE, Spring connection contacts SQUICH, 16A, 500V, 6kV, 3, silver plated, size "44.27", CLASS insert series

Product description	
Model	male insert
Version	SQUICH® Spring connection contacts
Series	CSH
Product type	with male contacts
Family	CLASS inserts
Size	size "44.27"
N. of poles	6 poles +
Technical data	
Current	16 A (A.C. and D.C.)
Voltage	500 V
Rated impulse withstand voltage	6kV
Pollution degree	3
Wire cross-section	0,14 mm <sup>2</sup> - 2,50 mm <sup>2</sup>
AWG size	26 - 14
Operating temperature range (min, max)	-50°C ... +70°C
Contact type	silver plated
Mating cycles	≥ 200
IP degree of protection	IP20 without enclosure; IP65/IP66/IP67/IP68 with enclosure
Further technical details	
Characteristics according to EN 61984	16A 500V 6kV 3; 16A 400/690V 6kV 2
Insulation resistance	≥ 1 GΩ
Rated voltage according to UL/CSA	600V
UL 94 flammability rating	V-0
Weight	57,00 g

Approvals / Standards	
Reference standard	EN 61984 (2001-11)
Quality mark	EAC
Conformity	CQC, CE
General ordering information	
EAN13 code	8015747053990
Tariff number	85369095
Country of origin	Made in EU (IT)
ETIM classification	EC000438
Packaging Information	
Packaging length	245,00 mm
Packaging height	165,00 mm
Packaging width	215,00 mm
Packaging weight	3,40 kg
Packaging volume	8,69 dm <sup>3</sup>
Packaging description	Carton box
Packaging quantity	60 Pcs
Packaging EAN code	8015747170727
Sub-packaging length	197,00 mm
Sub-packaging height	44,00 mm
Sub-packaging width	113,00 mm
Sub-packaging weight	0,57 kg
Sub-packaging volume	0,98 dm <sup>3</sup>
Sub-packaging description	Carton
Sub-packaging quantity	10 Pcs
Sub-packaging EAN barcode	8015747170734

Part number

# CSHM 06



Catalogue drawings

Catalogue drawings

dimensions in mm

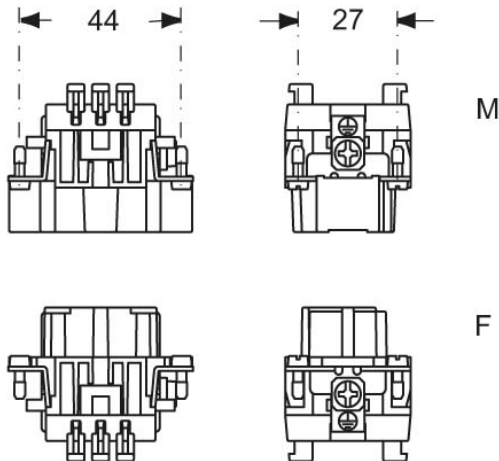

contacts side (front view)

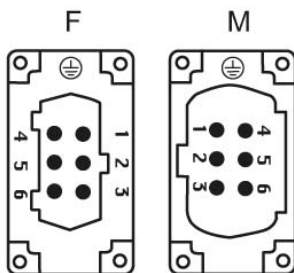
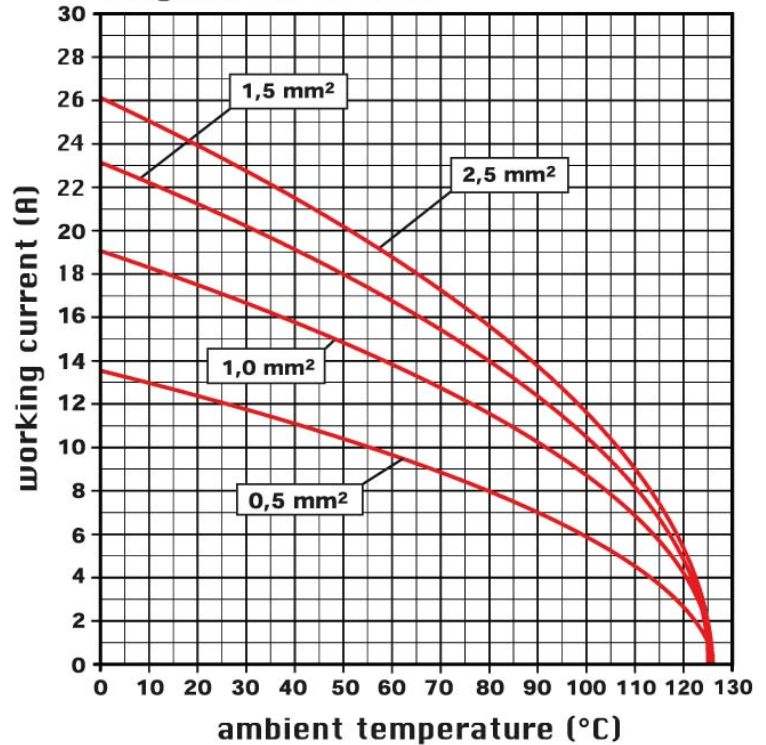

diagram CSH 06 poles



## Notes

CSHF/M 06

- characteristics according to EN 61984:

16A 500V 6kV 3

16A 400/690V 6kV 2

- rated voltage according to UL/CSA: 600V

- insulation resistance: > 10 GOhm

- ambient temperature limit: -40 °C ... +125 °C

- are made of self-extinguishing thermoplastic resin UL 94 V0

- mechanical life: > 500 cycles

- contact resistance: < 3 mOhm

- enclosures: size "44.27":

C-TYPE IP65/IP66

C7 IP67 stainless steel lever

V-TYPE IP65/IP66

stainless steel lever

T-TYPE IP65 insulating

JEI zinc-plated steel lever

BIG hoods

W-TYPE aggressive environments

EMC

central lever

IP68

- panel supports:

COB

actuator button connections

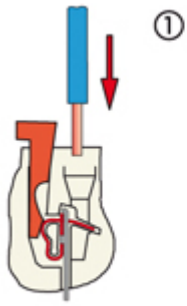

①

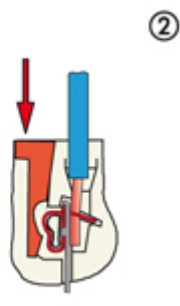

②

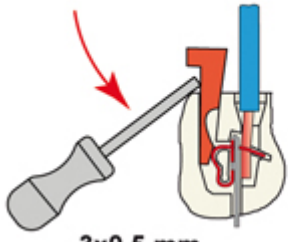

**3x0,5 mm**

Reopening

---